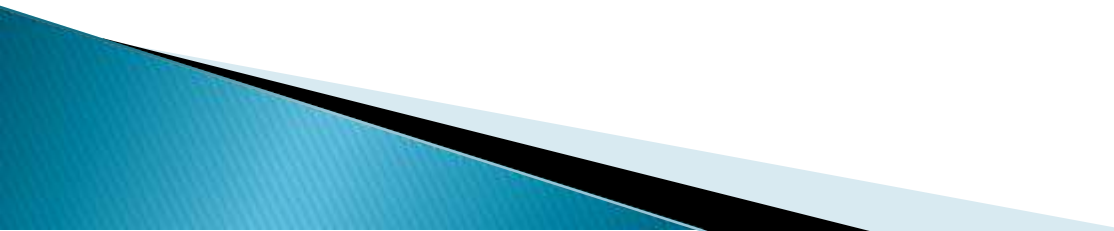

Center for Volunteer Services Online Data Management System

Presented by:
Kenneth Carpenter, Lisa Owen,
Brandon Helvie

Overview

- ▶ Volunteering
 - ▶ What is the Center for Volunteering Services (CVS)
 - ▶ How CVS provides this service
 - ▶ What our team has developed
 - ▶ Benefits
 - ▶ Implementation
 - ▶ Why this design?
 - ▶ Hindsight
- 

Volunteering

- ▶ **Benefits**
 - Scholarships
 - Resume Booster
- ▶ **Availability Problem**
 - Many Opportunities; Difficult to Volunteer
- ▶ **Center for Volunteer Services at UW**
 - Central Hub but inefficient

What is the Center for Volunteering Services

- ▶ On campus organization
 - What does it do
 - students/non students
 - Programs Offered
 - Alternative Spring Break
 - AmeriCorps
 - Organizational Opportunities

How CVS provides this service

- ▶ **Current System in Place**
 - Manual Input of information by limited staff
 - Hard Coded onto Website
 - Forms must be turned into the office
 - Organizations must meet or call
- ▶ **Problems with current system**
 - Time Consuming
 - Low Efficiency

What our team has developed

▶ Online System

- Available for
 - Organizations
 - Students/Non Students
- Database through ASP.NET pages
- For Organizations
 - Opportunities uploaded online
 - New Organizations
 - Information can be viewed by all
- Views

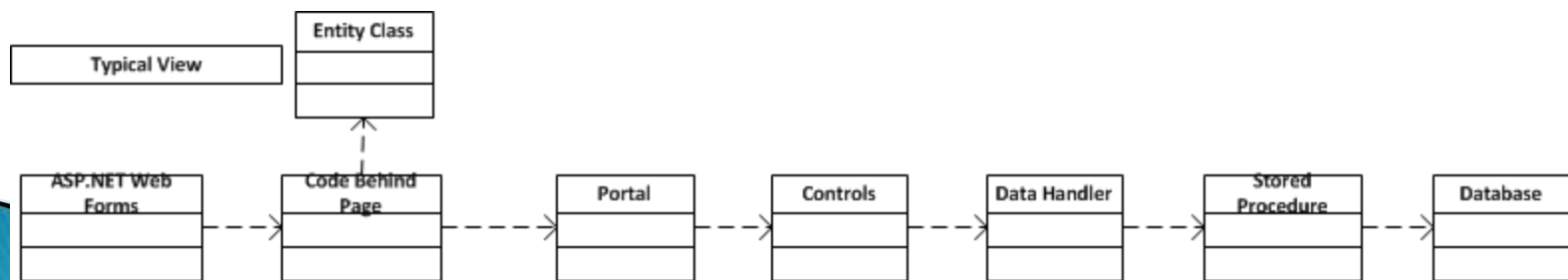

What our team has developed

Cont...

▶ Organizations Cont...

- All information uploaded viewed by Admin
 - Stops malicious information

▶ Users

- Can view all opportunities from anywhere with internet access
- Can submit online forms
 - Ex: Alternative Spring Break (Alternative Breaks)
- Uploaded to database automatically
- All forms viewed and accepted by admin
 - Stops malicious information
- All forms are convertible to PDF
 - Printable

Benefits

▶ CVS Benefits

- Increases efficiency
 - Less manual input
 - More time for other tasks
 - No hard coding

▶ Users

- Increases reach
 - Do not have to visit office
 - All forms online
 - All opportunities online just a click away

Implementation

- ▶ Volunteer Opportunities
 - Open access showing all Opportunities
 - Allowed us to test data changes
 - Introduction to the Project

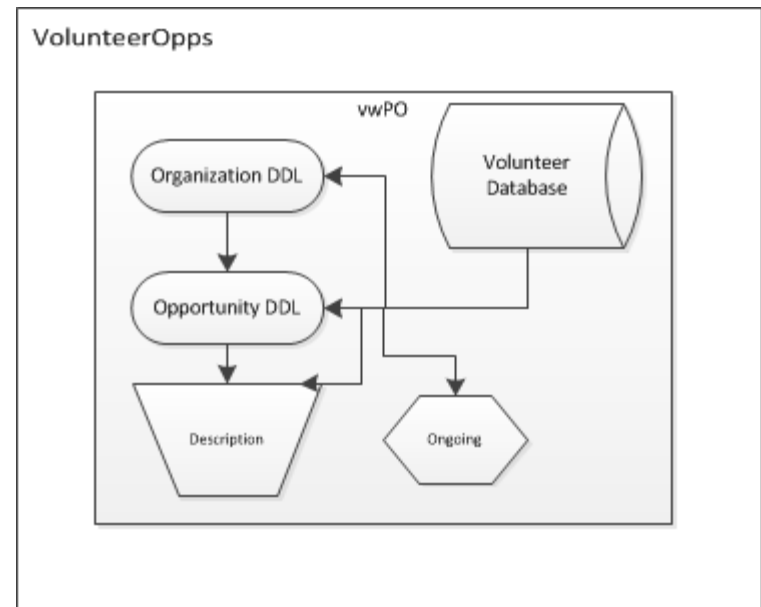

Implementation

- ▶ Partner Organizations
 - Purpose of the pages
 - Only Organizations have access
 - All submitted changes and additions reviewed by admin

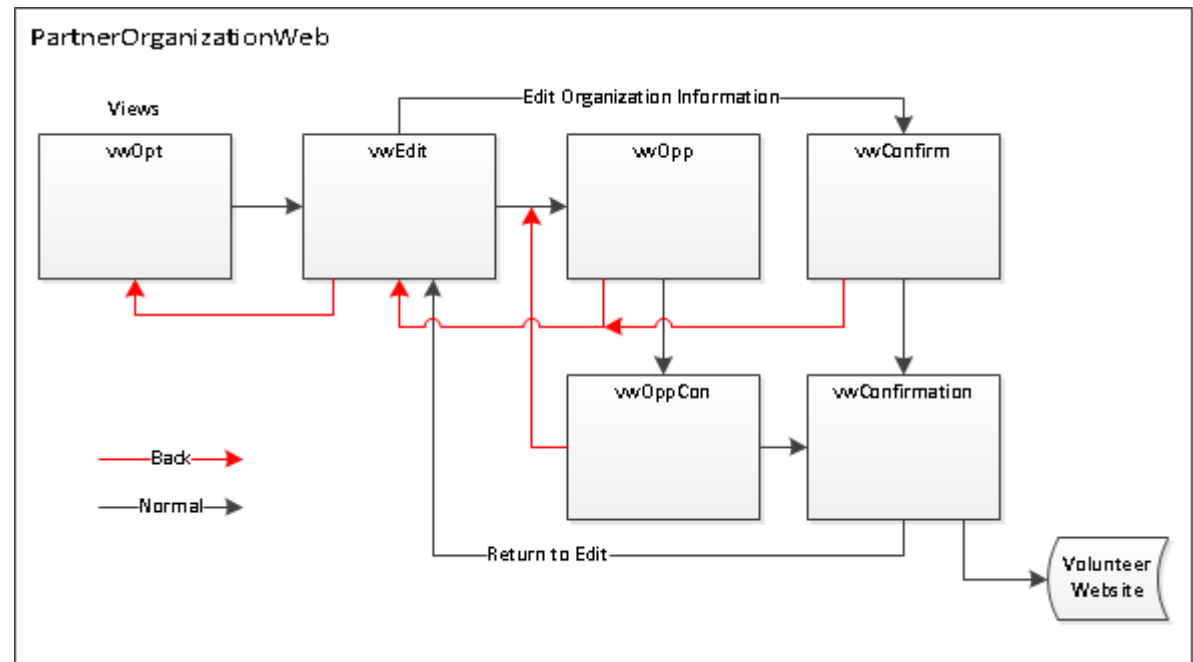

Implementation

- ▶ Alternative Breaks
 - Submit Form
 - Email
- ▶ AmeriCorps Form
 - Submit Form
 - Email

Alternative Breaks

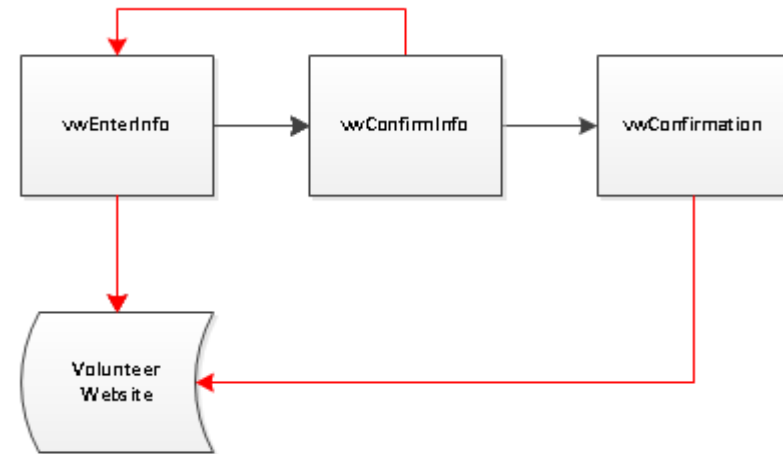

AmeriCorpsApply

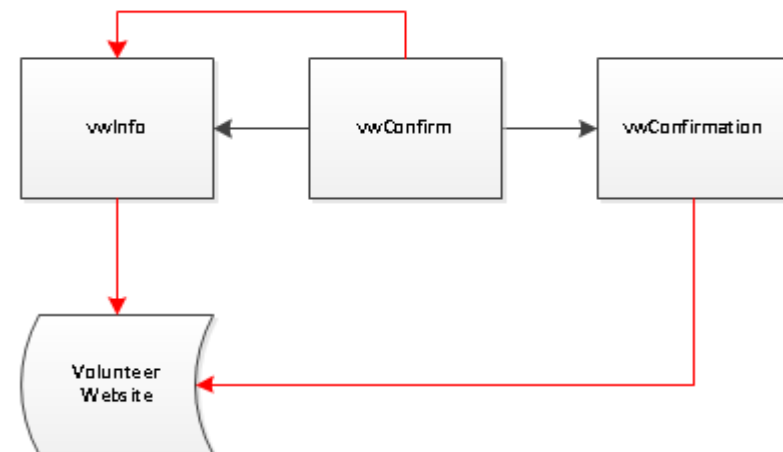

Email

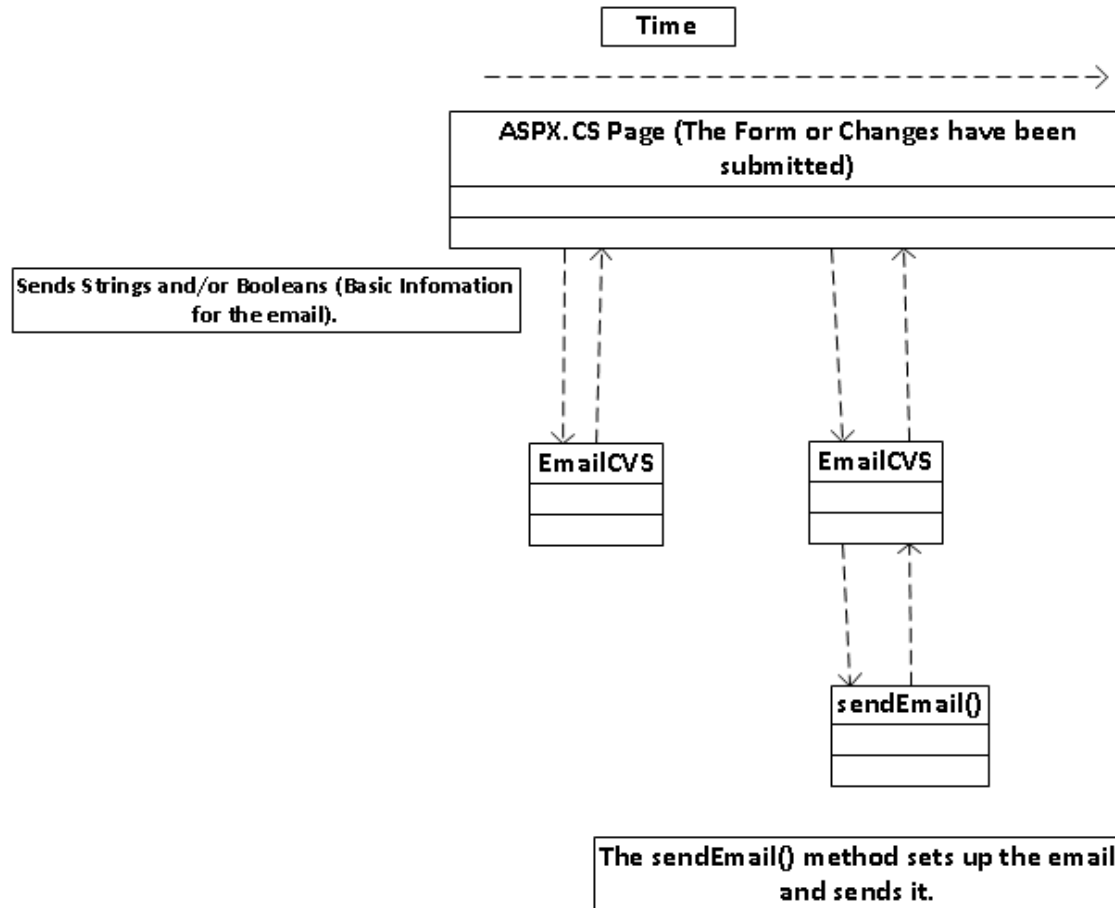

Implementation

- ▶ Admin Controls
 - Used by CVS employees
 - Approves student application submissions
 - Approves changes to Organization Information
 - Manages data and information submitted to the database

AdminWeb

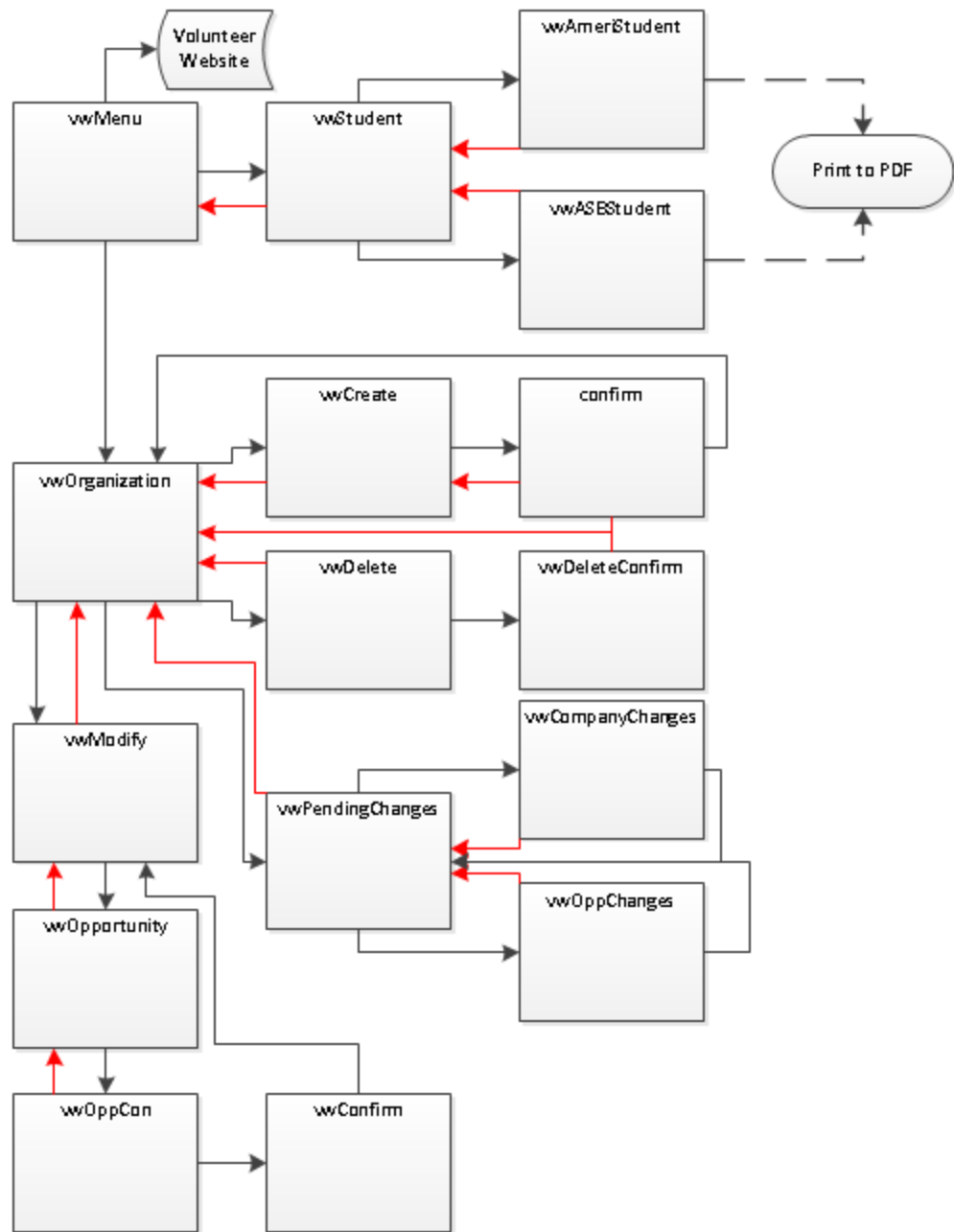

Implementation

- ▶ Web Form to PDF
- ▶ Uses itextsharp open source library

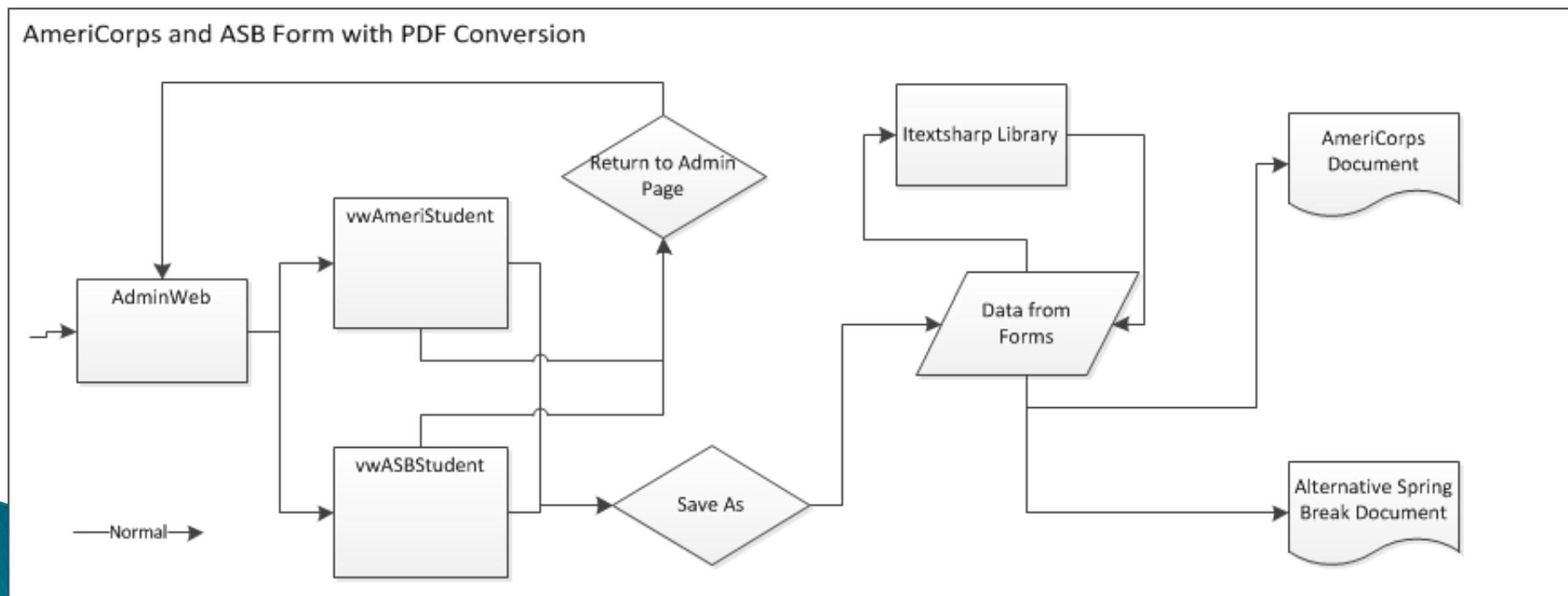

Why this design

- ▶ Exactly what the client needs/requested
 - Simple design
 - Saves time
 - Easily Modified
- ▶ Uses a similar process as before
 - Easier for client to adapt and accept
- ▶ Appearance / Layout
 - Format fits CVS website requirements
 - Easily Adjustable

Hindsight

- ▶ Admin Page
 - Layout
 - Elegance
- ▶ Deployment Server Setup
 - Change in Webpage
 - Access Permissions

This concludes our Presentation
QUESTIONS?

